

Kumo Sofa

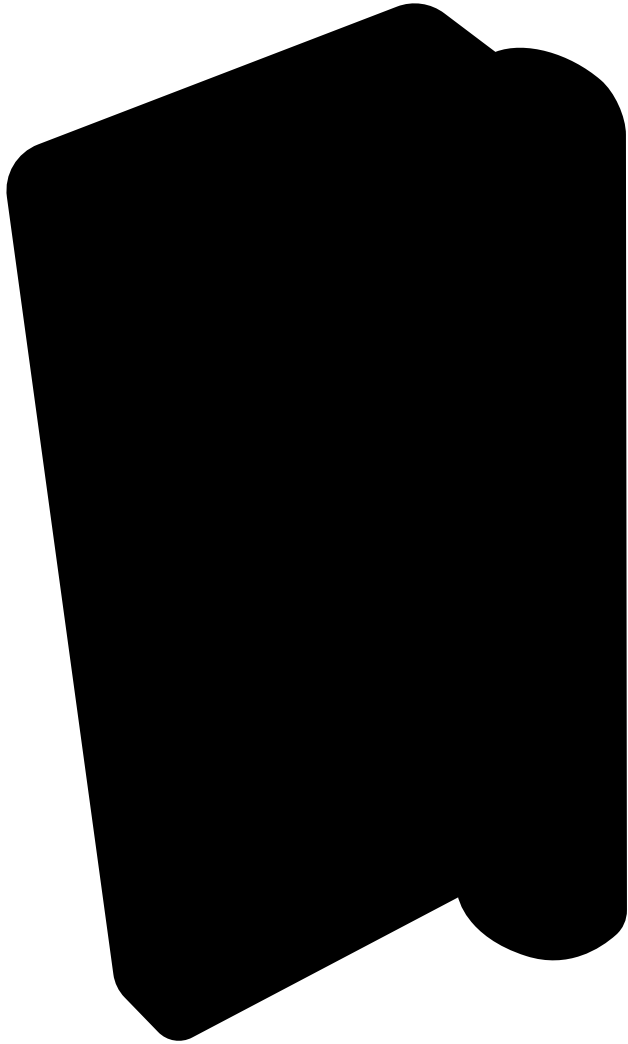

**Assembly
Instruction**

Kumo Sofa

The Kumo Sofa system is built around an innovative metal frame onto which individual cushion components are added. This intelligent design from Anderssen & Voll makes Kumo especially convenient to live with—readily reconfigurable whenever and however you wish. Kumo is also efficient and responsible to ship thanks to the same quality: it dismantles easily. Like its namesake—Kumo means “cloud” in Japanese—this sofa is light and soft as well as clever, with generous, foam-filled cushions covered in a luxurious, highly textured woolen fabric as a final flourish.

Please note: The exact number of the parts in your package vary with each Kumo configuration.

Parts: Building the Kumo 3-seater Sofa



Knob

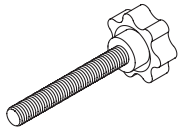

Screw

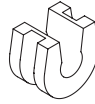

Plastic fitting

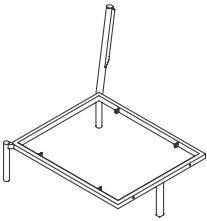

End frame

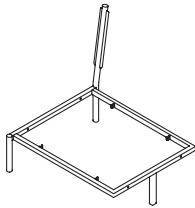

Extension frame

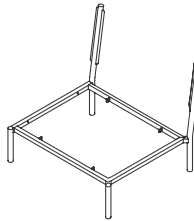

Start frame

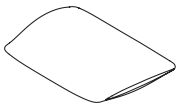

Side view



Top view

Straight backrest

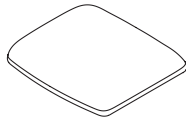

Side view

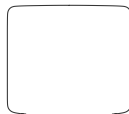

Top view

Seat

Please note: The Kumo Sofa 3-Seater consists of a Kumo Sofa 2-Seater + extension module, The Kumo Sofa 4-Seater consists of a Kumo Sofa 2-Seater + two extension modules.

Step 1

Starting with the start frame, the right hand side of the final sofa, click in all the plastic fittings with the help of a screw driver, in case they're not in place.

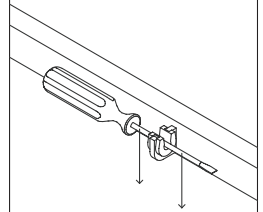
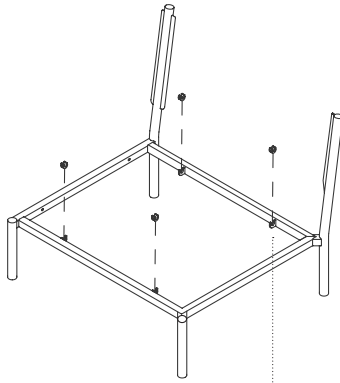

Step 2

Attach the extension frame to the start frame by using the screws provided as seen on the picture below.

Repeat the same process with the last frame, the end frame, until your sofa frame looks ready assembled.

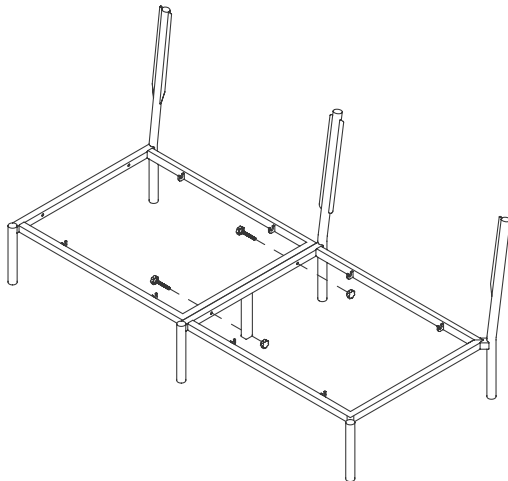

Step 3

Your Kumo 3-seater frame should now look like this from the top.

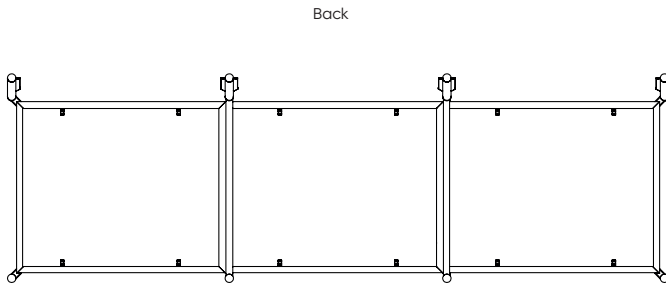

Front

Back

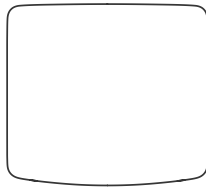

Front

Next, get familiar with the direction of the seat cushion before continuing with step 4.

Step 4

Next, click the seat cushions into the frame. Start from right to the left side.

When you hear a click sound, the cushions sit tightly in the frame. Use your knee for more force.

Double check, that you have clicked the seats in correctly and facing the right way.

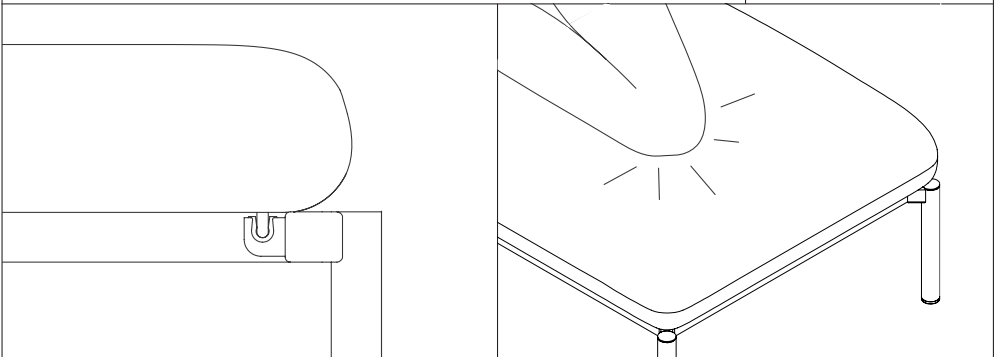
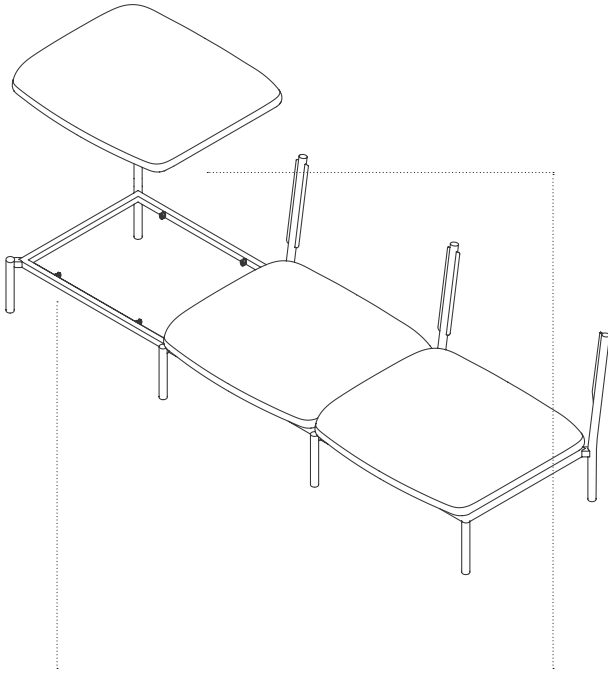

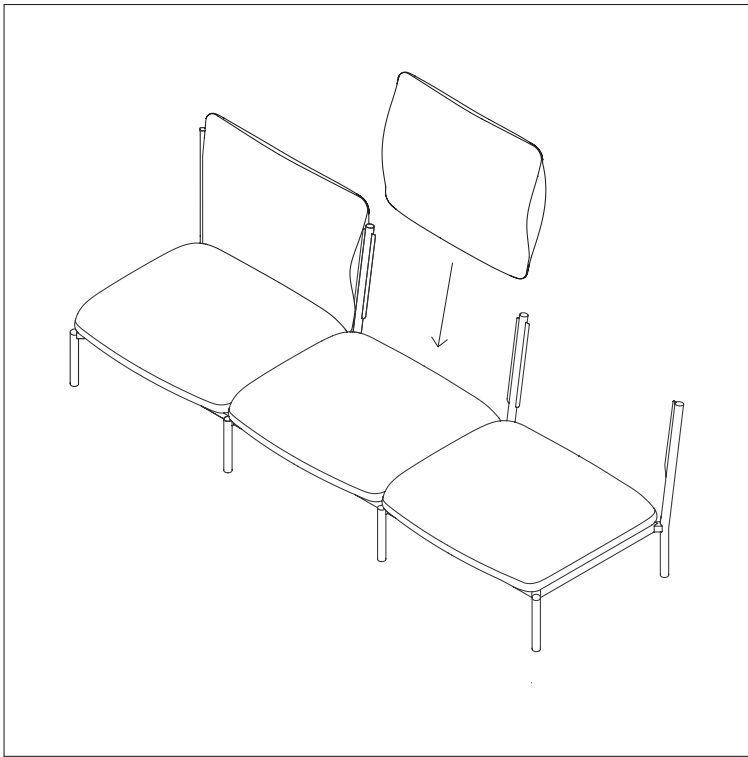

Step 5

Start from left to the right side for easiest assembly.

Slide in the first straight backrest cushion on the left side.

Then, slide in the second straight backrest cushion in the middle.

Step 6

Lastly, slide in the last straight backrest cushion.

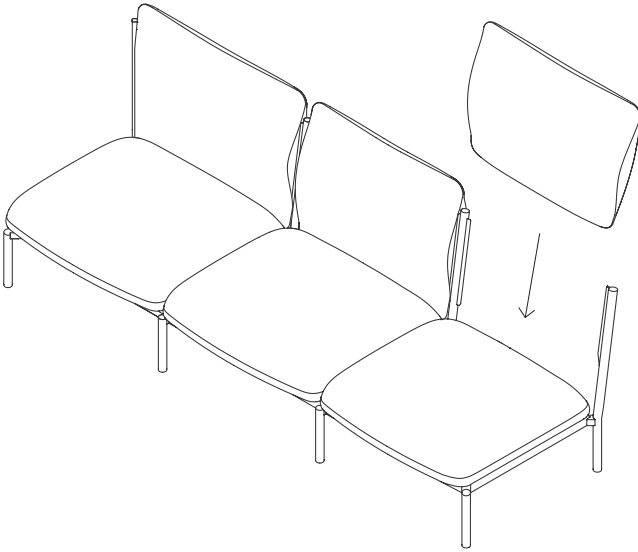

Step 7

Your Kumo 3-seater Sofa is now ready assembled!

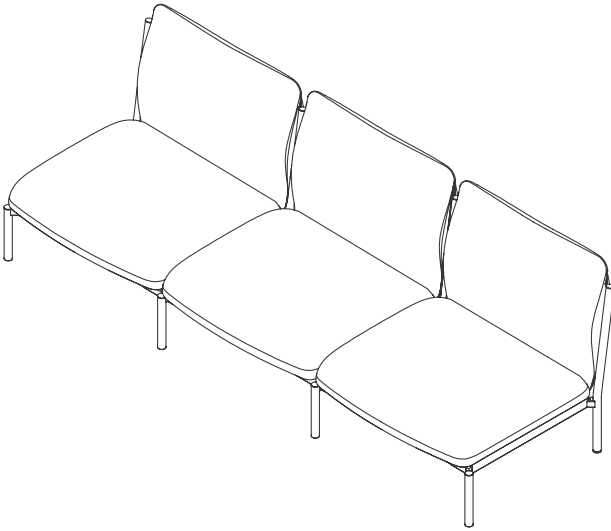

Notes

Notes

Should you have any problems assembling your product, contact us at info@hem.com. We're always happy to help!

Hem